

THE INFLUENCE OF CRUDE OIL PRODUCTS ON RC STRUCTURE DESTRUCTION

Tomasz Z. Błaszczyński

*Department of Building and Environmental Engineering, Institute of Structural Engineering,
Poznan University of Technology, Piotrowo 5, 60-965 Poznan, Poland*

E-mail: tomasz.blaszczynski@opal.info.pl

Received 29 Dec. 2009; accepted 15 Oct. 2010

Abstract. It is known that RC industrial structures are liable to the effects of crude oil products, which may have a disadvantageous influence on their exploitation and safety. Within this research, the influence of crude oil products on the physico-mechanical properties of mature concrete, as well as other possible mechanisms of RC progressive failure have been analysed. Crude oil products with a very low neutralisation number were found to be physico-chemical active agents affecting concrete. Experimental analysis undertaken in order to assess the compressive strength of concrete and its bond to reinforcements is described. Long term investigations were conducted in order to determine the effects of a group of crude oil products – mineral oils – on the properties of concrete and reinforced concrete samples. Detailed results of this research are included in the paper. Comparing the influence of different mineral oils on the compressive strength of concrete, leads to the conclusion that there are large differences in their effects. The paper also attempts to answer the question of how the characteristics of RC structure bonds change over time of exposure to mineral oils. The problem of the influence of organic agents on concrete and its bond under conditions of natural humidity is mainly linked to its structure. In the case of oil products, there are four possible mechanisms i.e., biological, chemical, physical and physico-chemical, affecting concrete, its bond and, sometimes, reinforcements. Each of these mechanisms is presented. Necessary laboratory tests were performed in order to prove the thesis that the content of active surface polar molecules in active agents is the reason behind concrete damage brought about by crude oil products. The conducted experiments demonstrated that the effects of artificial environments (on concrete) prepared by the author, are the same as those of widely used industrial mineral oils.

Keywords: RC structures, influence of crude oil products, concrete destruction mechanisms, compressive strength, bond stress, surface active polar molecules.

1. Introduction

In technical literature, the effects of crude oil products on concrete are classified either as non-harmful or only mildly harmful; however, there is evidence that serious damage can occur as a result of such products (Миловидов, Алексеева 1970; Pluta *et al.* 1980; Khoury 1981; Błaszczyński 1995; Onabolu 1986). Oil products affect tank walls, foundations and other constructions supporting machines, and storage floors, therefore, the range of the problem is wide and the subject should be considered of great technical importance, especially when regarding industrial construction. Inspection of frame foundations used for large power turbines (Fig. 1) showed that, with the passing of time, considerable damage can be observed. The damage, mainly cracks and fissures, and a decrease of the structure's dynamic stiffness, often causes serious damage to the turbines. It was also noted, that strong oiling of the foundations is one of the main factors causing these damages (Błaszczyński *et al.* 1985).

Near the bottom slab of the foundation, a water-oil environment, which causes damage through the biological mechanism of destruction, can be observed (Fig. 2).

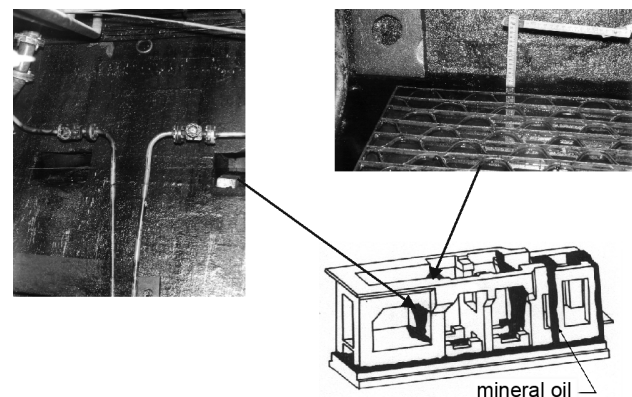

Fig. 1. Observed damage of a turbine's frame foundation

The oiling of structural elements is a problem also present in industrial buildings. Strongly oiled, reinforced, concrete floors display considerable damage, which often impairs a building's exploitation. After a few years, significant enlargement of cracks brought about by the influence of oil can be observed (Миловидов, Алексеева 1970; Pluta *et al.* 1980). Biczok (1972) presented an example of an oiled, reinforced, concrete floor in which

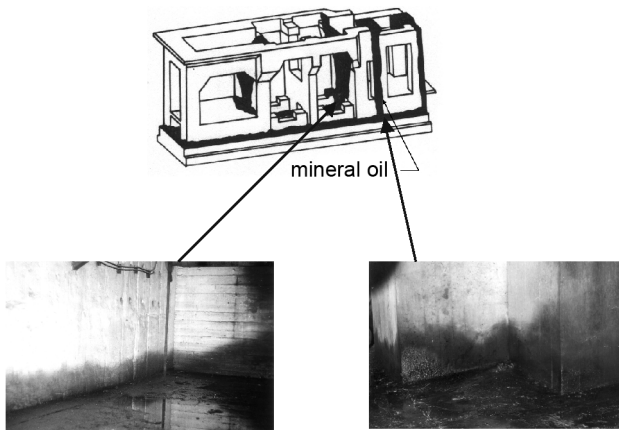

Fig. 2. Area near the bottom foundation slab of the turbine's frame foundation

significant cracking and deflection occurred and, during repair work, concrete was easily separated from the reinforcement bars (Fig. 3a). The same problem was noticed in the floors of industrial buildings (observed at the Social Psychology University in Warsaw, recently analysed by the author) (Fig. 3b).

Biczok (1972) noted that concrete specimens taken from the oiled floor demonstrated a decrease in strength of up to 40%. This was also shown in Manns and Hartmann's as well as Wasiliew's research (Manns and Hartmann 1977; Васильев 1981). On the other hand, Grabiec (1973) presented contradictory results regarding oiled concrete; in his research, the relatively long-term oiling of samples (about 5.5 years) did not cause a decrease in compression and tensile strength below the initial values. During his investigations, Grabiec used various mineral oil types: Lux 10, Wrzecion 2 and TZ-4 water-oil emulsion (5:1). Similar results were obtained by Dominas

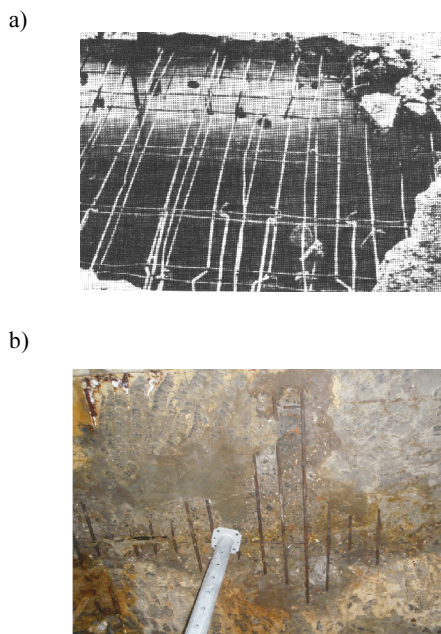

Fig. 3. Destruction of structural floors contaminated by mineral oils: a) floor observed by Biczok (1972); b) floor of the Social Psychology University in Warsaw, observed by author

(1970) for Wrzecion 2 oil. Nevertheless, the latest research by Runkiewicz *et al.* (2002) demonstrates that oiling concrete with mineral oils adversely affects the mechanical characteristics of concrete. The researchers used machine oil (L-AN 22) and cooling emulsion (EMULGOL ES12), with the period of research lasting 1260 days (almost 4 years).

The influence of Hydrocarbon-products (crude oil products) over a long period of time in comparison to water was presented by the author in earlier research (Błaszczczyński 1994). The results of these studies varied greatly: from a lack of influence observed in the case of kerosene, petrol, or vaseline oil, to significant changes caused by certain mineral oils.

The author's longstanding research focusing on the influence of mineral oils on mortars and cement-based concretes, has led to rebuttal of the thesis concerning the considerable influence of the viscosity of crude oil products, especially mineral oils, on the degree of concrete destruction, and enabled one to discriminate between more and less destructive substances from the mineral oils group; such findings contradict a common thesis that assumes equal affects of all mineral oils (Błaszczczyński 1994, 2002).

Current research pertaining to the influence of mineral oils on the adhesion of plain reinforcements to oiled concrete was conducted by Runkiewicz *et al.* (2002). His investigations, conducted by means of the pull-out method, incorporated plain bars (steel St0) of \varnothing 14 mm. After about 4 years of subjecting the given material to the effects of mineral oils, a fall of maximum adhesion from 17% to 33% was reported.

2. Methods, materials and results

2.1. Influence of mineral oils on concrete

Long-term laboratory experiments have been conducted to assess changes in the physico-mechanical characteristics of concrete contaminated by oil. The compressive strength was determined, with the use of 100 mm cubes and in accordance with PN-EN 12390-1:2001, for concrete type – B25, which is the most commonly used concrete type for industrial RC structures in Poland (5 specimens, standard deviation $s_{fc} = 0.84 - 2.87$, variation index $v_{fc} = 2.25\% - 6.99\%$). The average 28 day compressive strength of concrete equalled $f_{cm1} = 29.8$ MPa. The water-cement ratio was 0.59, while the aggregate-cement ratio equalled 6.70. Three different oils were used in the research: TU-20, M-40 and H-70 with respective viscosities of $81.0 \text{ mm}^2/\text{s}$, $211.4 \text{ mm}^2/\text{s}$, and $383.0 \text{ mm}^2/\text{s}$, at 20°C . These oils have low neutralisation numbers with values between 0.05 and 0.075 mgKOH/g . The first application of oils to concrete took place 2 months after casting; subsequently, the specimens were examined every 4 months (up to the 36th month), and every 12 months (from the 36th month onwards) over a period totalling 72 months. The control specimens (samples) were additionally examined 28 days, and 2 months after the application of oils. The concrete was oiled two months after casting, which marks the beginning of the

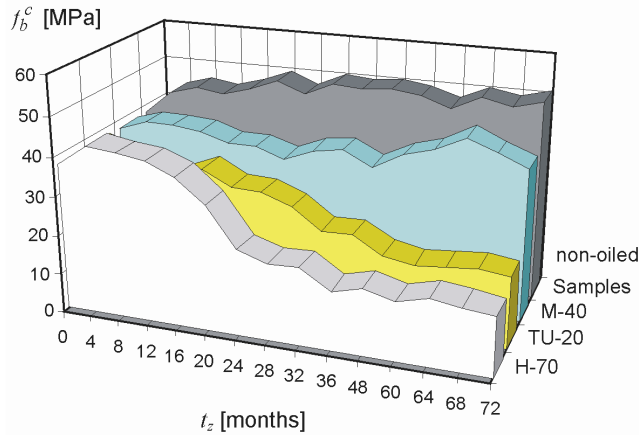

Fig. 4. Variation of concrete C20/25 compressive strength over the period of exposure to H-70, TU-20 and M-40 oils

time of oiling t_z , when the average compressive strength of concrete $f_{cm} = 37.35$ MPa. Comparison of the influence of oils on compressive strength shows that oils TU-20 and H-70 decrease f_b^c the most. Changes in the compression strength of concrete f_b^c are presented in Fig. 4.

The results illustrate, that the significant decrease of f_b^c occurs as a result of contamination with oils. Comparison of the influence of oils shows that TU-20 and H-70 oils are responsible for the largest decrease in f_b^c . When comparing the effects of oils used it should be noted that the final f_b^c values of concretes exposed to oils differ significantly from the control group, and range from 55% (H-70 oil) to 10% (M-40 oil). While a considerable decrease in f_b^c occurred after the application of H-70 and TU-20 oils, M-40 oil (of medium viscosity) did not cause a decrease in f_b^c below the initial value.

2.2. The influence of mineral oils on concrete bond

Conventional reinforced concrete structures are designed under the assumption that concrete and steel bars work together in carrying loads. The collaboration of steel and concrete, based mainly on adhesion (natural adhesion) and friction (in the case of plain bars), as well as mechanical bond (in ribbed bars), is a distinctive feature of reinforced concrete. In the case of plain bars, with a surface roughness coefficient of $R_a \leq 0.1 \mu m$, the value of the bond depends only on natural adhesion. A solution to the problem of the influence of mineral oils on the natural adhesion of concrete to plain reinforcements was sought through experimental research conducted on specimens of the author's own design (Fig. 5).

The character of changes in the case of the influence of crude oil products on the bond between ribbed bars of different ribbed ratios f_R (Manns and Hartmann 1977) and concrete, differs.

Changes in the natural adhesion of investigated concretes to plain bars over time following oiling with TU-20 mineral oil is illustrated in Fig. 6.

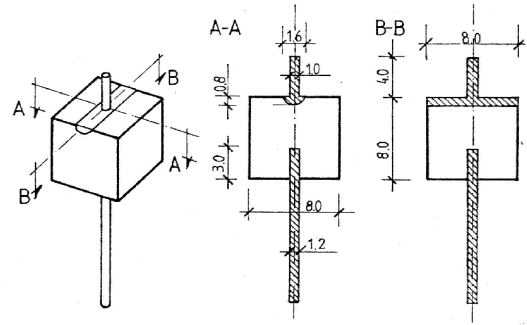

Fig. 5. Specimens for testing natural adhesion of plain bars to concrete (dimensions in cm)

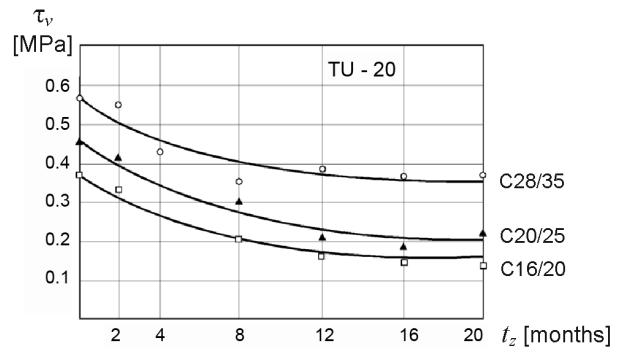

Fig. 6. Changes in the natural adhesion of concrete to plain steel following oiling with TU-20 oil, where C28/35, C20/25 and C16/20 are the grades of concrete according to Eurocode EN 206-1:2000

Almost all tests designed to assess bond stress utilize the pull-out method, executed in accordance with guidelines specified by the Committee Mixed RILEM/CEB/FIB Doc. 7.11.128 (RILEM/CEB/FIB 1983). Pull out specimens presented in the above guidelines have dominated experimental research. Experiments on specimens with a very short transfer length are relatively inexpensive and simple to conduct, especially when taking into account the quantity of samples. On top of this, they allow one to study many interesting parameters, e.g., rib patterns (Soretz and Hölzenbein 1979; Kimura and Jirsa 1992), concrete strength (Esfahani and

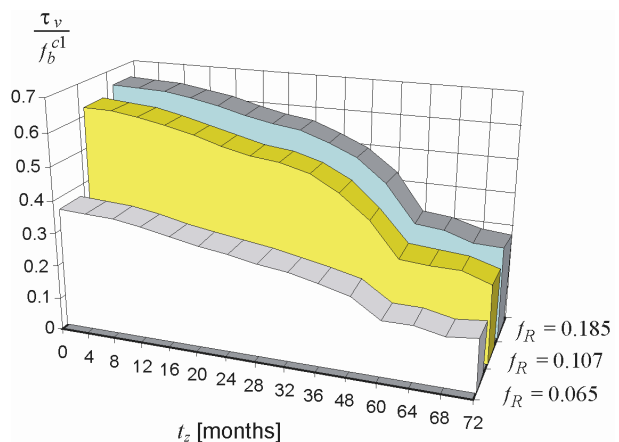

Fig. 7. The degradation of ribbed steel bars' bond to surrounding concrete as a result of TU-20 oil, where f_b^{c1} is the compressive strength of non-oiled concrete, τ_v is average bond stress

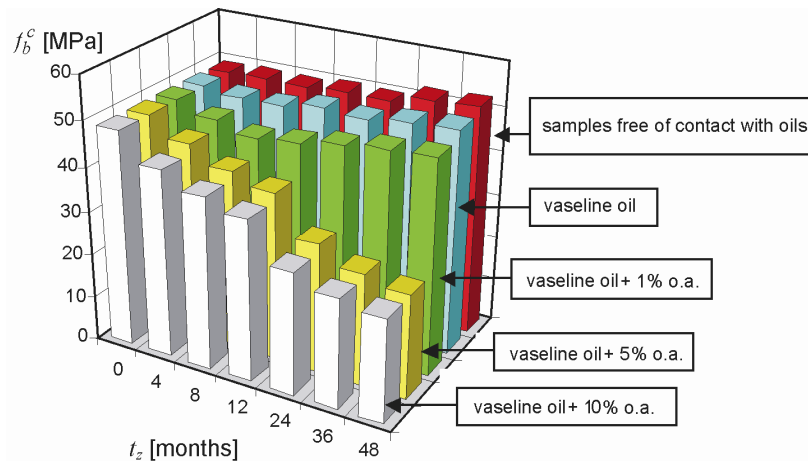

Fig. 8. Variation in the compressive strength of concrete during a period of exposure to different artificial environments

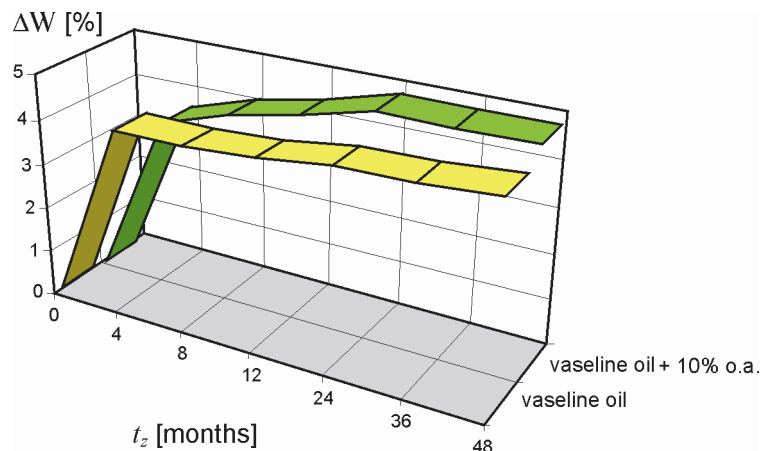

Fig. 9. The penetration intensity of vaseline oil and vaseline oil with the addition of 10% oleic acid into a concrete structure

Rangan 1998), and the influence of different products (Błaszczński 1995). However, the behaviour of such specimens differs greatly from that of a cracked concrete structure (Pędziwiatr 2008).

Changes over time in the bond stress of analyzed concretes and ribbed bars, following oiling with TU–20 mineral oil and tested for by means of the pull-out method, are shown in Fig. 7. The decrease in bond is gradual and, as in the case of concrete compressive strength, takes six years to stabilize (Fig. 4).

2.3. Investigations incorporating artificial, physico-chemically active environments

In order to prove the physico-chemical mechanism, an artificial environment was prepared. It was composed of a mix of vaseline oil (basic oil – not active) and oleinic acid (improver – surface active fluid). 100 mm concrete cubes, made of grade C20/25 concrete were exposed to four different artificial environments i.e., vaseline oil, vaseline oil with 1% oleinic acid, vaseline oil with 5% oleinic acid and vaseline oil with 10% oleinic acid, six years after casting. Subsequently, the compressive strength of concrete was examined over a period of 4 years, as presented in Fig. 8.

As illustrated in Fig. 8, only vaseline oil is non-harmful to concrete. The addition of oleinic acid (surface active molecules) has a similar effect on the compressive strength of concrete as the analyzed mineral oils (Fig. 4). The intensity of the penetration of two artificial environments i.e., vaseline oil and vaseline oil containing 10% oleinic acid, was also examined by measurement of the increase in the values of mass (Fig. 9). Nearly complete saturation of samples occurred within a period of 12 months. After this time, the decline in strength could be caused only by the destructive processes of the added surface-active substance (oleinic acid). Significant differences were not observed between the kinetics of saturation and the increase in mass in either of the applied environments. Thereby, it was confirmed that physical phenomena, such as the heave of penetrating material or its filling in of gaps, were not the reasons behind changes illustrated in Fig. 8.

3. Concrete and its bond destruction mechanisms caused by crude oil products

The reasons behind the destruction of concrete structures are usually complex, nevertheless, a dominating cause can generally be established. In the case of crude oil

products, there are four possible mechanisms of concrete destruction i.e., biological, chemical, physical and physico-chemical. The same mechanisms damage bonds between concrete and steel reinforcements, and are due mainly to the properties of concrete.

3.1. Biological and chemical mechanisms

In water-oil systems, two groups of bacteria develop: aerobic oil oxidizing bacteria – OOB, and anaerobic sulphate reducing bacteria – SRB (Morgan *et al.* 1983). The first group grows on crude oil molecules, while the later, on water molecules. OOB growth on crude oil molecules appears earlier than SRB development in water containing crude oil molecules, which suggests that a form of nourishment symbiosis is present between them (Dahan 1984).

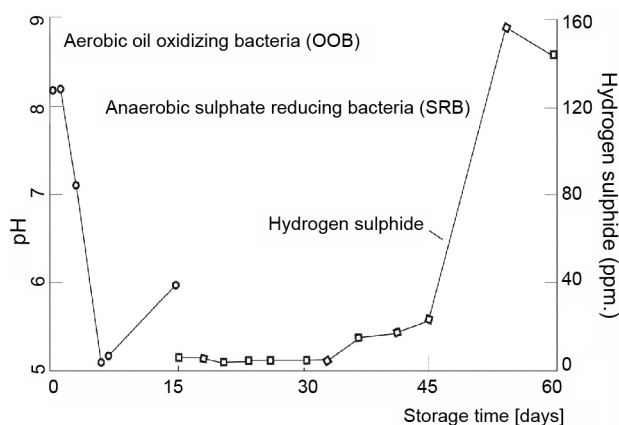

Fig. 10. Fall of pH value, and H₂S production during growth of oil oxidizing bacteria (OOB) and anaerobic sulphate reducing bacteria (SRB) in an oil-water environment (Morgan *et al.* 1983)

OOB produce organic acids, mainly acetic acid (CH₃COOH) and, in effect, lower the pH of water. SRB produce hydrogen sulphide (H₂S) and do not cause a decrease in pH values (Fig. 10 and Postgate 1979). The extent of their growth and the level of H₂S production are directly connected with the presence of crude oil and its products (Wilkinson 1983).

In the case of crude oil, the presence of 50–100 mg/l H₂S was reported (which is 3–5 times higher than the limiting standard value), with pH values decreasing from 8.4 to 6. Sulphur bacteria i.e., Thiobacilli X and Thiobacilli Concretivori, present under these conditions, cause the oxidation of hydrogen sulphide, production of sulphuric acid (H₂SO₄), and a decrease in pH to values of 2, 3, and even 1.

Onabolu *et al.* (1985) state that this acid is not intercepted from water by crude oil, even at a very low pH value (2.2) and high temperature of the environment (80 °C).

The following factors are responsible for the induction of chemical destruction of concrete structures, in an environment of crude oil products:

- a decrease in pH value of the oil-water environment, caused by the presence of aerobic bacteria

and sulphate bacteria, existing in an anaerobic bacteria environment;

- organic acids produced by aerobic bacteria (acetic acid), and acids remaining after the refining process of crude oil, or created as a result of the exploitation of its products (machine and engine oils);
- a hydrogen sulphide water solution produced by anaerobic bacteria;
- sulphuric acid produced by sulphate bacteria;
- sulphur and its compounds contained in crude oil and its products.

In summary, two kinds of chemical destruction mechanisms are dealt with: a generally acidic (pH value decrease of the oil-water environment, organic acids) and sulphate (sulphur and its compounds).

The effects of acids on concrete include reduction of its strength, a decrease in weight, an increase in cement stone dissolution or porosity, and the exposure of aggregate grain (Czarnecki *et al.* 1994). The degradation process depends on the pH value of the environment. Destruction is to be expected at pH values below 6.5; for instance, according to Romben (1978), concrete destruction at pH values between 3 and 6 proceeds in an extent proportional to the square root of action time.

The effect of organic acids on concrete, similar to that of non-organic acids, is based on the reaction with calcium hydroxide and, partly, with aluminium compounds. Acetic acid, produced by bacteria, reacts with free hydroxide or calcium oxide, creating soluble calcium acetate (Kawai *et al.* 1997) which, in turn, causes calcium loss; therefore, even thinned solutions are strongly aggressive. Other carboxyl acids (for example oleic acid or stearic acid) react with Ca(OH)₂, creating soft, insoluble lime soaps (calcium oleate or calcium stearate). If there is a large inflow of these acids, after Ca(OH)₂ runs out in the cement, decomposition of calcium silicates can take place, along with silicate gel precipitation and the formation of further calcium soaps. This leads to the softening or cracking of concrete (Gruener 1983; Ściślewski 1999).

The acid content of crude oil and its products is specified in its neutralization number, which equals the amount of KOH (in milligrams) needed to neutralize unbound acids present in 1g of the given product (PN-85/C-04066). According to Steinbach (1967) and Weiss (1961), chemical reactions of non-vegetal oils can be expected only if the neutralization number is greater than 0.25 mg KOH/g. This value is alleged to be the chemical limit of concrete structure destruction caused by crude oil products (*Vorläufiges Merkblatt...* 1966). However, in research involving oiled concrete (Manns and Hartmann 1977) it was reported, that despite the use of exploited machine oil (neutralization number equal to 0.48 mg KOH/g), no chemically induced damages were observed. The damages were of physico-chemical origin. In more recent works, the limiting value has been increased to 0.5 mg KOH/g (Tscherner 1986), or even 1.0 mg KOH/g (Brauer 1985). Nevertheless, in practice, it is recommended to employ the safest (initial) value of 0.25 mg KOH/g. Below this value, the presence of polar organic

acid molecules (including the – COOH group) in crude oil products affect the concrete structure physico-chemically more so than chemically. This does not mean, however, that organic acids with a neutralization number <0.25 mg KOH/g do not cause the chemical reactions described above, but rather that the quantity of products (lime soaps) resulting from these reactions does not lead to corrosion and structural changes in the concrete.

The chemical influence of mineral oils was investigated by Wasiliew (Васильев 1981). He proved that organic acids, present in these oils, react chemically with $\text{Ca}(\text{OH})_2$ and, thus, create soft lime soaps, causing the softening of concrete, and destruction of samples after just one and a half years. The research did not specify what neutralization number characterized the examined specimens.

For experimental purposes, the influence of various acids on the acidity rate of crude oil was tested. Fig. 11 illustrates the effects of organic (acetic) and non-organic (nitric) acids, as well as two organic (acetic and oleic) acids on oil acidity. When the content of acetic acid reaches 0.05%, crude oil becomes an aggressive environment for concrete, while at 0.5% it has a neutralization number of 5.12 mg KOH/g and, therefore, creates a very aggressive environment. The addition of non-organic acid did not cause crude oil acidity to change (Fig. 11a) (Khoury *et al.* 1985).

Comparison of high- and low-carbon, organic acids allows one to conclude that their acidic characteristics decrease along with an increase in the amount of carbon atoms in the compound (Fig. 11b). From the author's research on the influence of the addition oleic acid on crude oil and the neutralization number of its product, it can be stated that when the content of this acid significantly exceeds 10% of the volume, the lowest safety limit (0.25 mg KOH/g) for the chemical destruction mechanism is surpassed. In practice, however, the content of this type of acid does not exceed a few percent.

It can, therefore, be stated that concrete corrosion caused by organic acids can occur only under the influence of acetic acid and is not to be expected in the case of

crude oil products containing high-carbonic acids (oleic and stearic acids).

Acetic and sulphuric acids are classified as factors causing fast corrosion of concrete. Over extended periods of time (a few years), even H_2S causes detrimental changes (Gruener 1983). Chemical reactions between concrete and sulphuric acid, as well as other sulphur compounds, result in the formation of compounds containing soluble calcium hydrogen which, in turn, makes concrete weaker and more porous (Piasta, J. and Piasta, W. G. 1994).

When acids or their salts solutions are able to reach the reinforcement through pores and cracks, corrosion of reinforcements occurs, causing further cracking and peeling of concrete.

3.2. Physical and physico-chemical mechanisms

In the case of liquids, the physical destruction mechanism generally occurs as a result of internal pressure caused by bulking which, in turn, usually takes place due to changes in temperature. However, during the exploitation of crude oil products, temperature changes range from 15°C to 80°C , which does not result in pores and micro-cracks expanding notably and, thus, is not followed by an increase in internal pressure.

Extensive studies of literature, as well as the author's own research, did not confirm any signs of concrete damage by crude oil products, stemming from the physical mechanism of destruction.

The phenomenon, which can be termed “the physico-chemical mechanism of concrete destruction by organic substances”, is comprised of three basic elements:

- surface energy reduction in the concrete's structure due to active substance absorption;
- the wedging effect;
- the insufficiency of concrete strength due to its hydrophobization, caused by the lack of hydration.

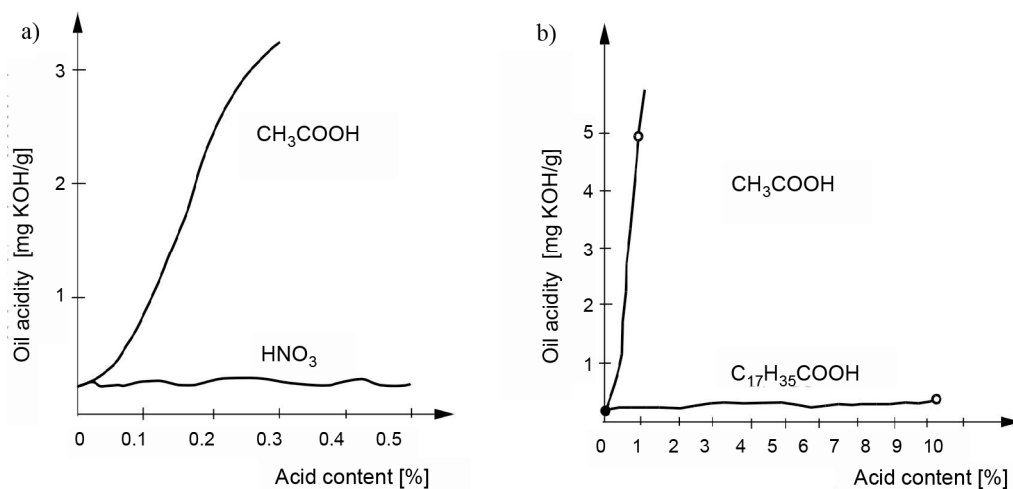

Fig. 11. The influence of organic and non-organic acid content on oil acidity: a) acetic acid and nitric acid (Khoury *et al.* 1985); b) acetic acid and oleic acid

Relevant substance absorption can occur only when connected with a decrease of free energy in this layer, hence, along with a drop in interfacial tension. The ratio of surface tension to concentration in a balanced state was labelled as absorbing substance surface activity by Rebinder (Рибиндер 1966), which characterizes the absorbing substance's ability to change the interfacial tension of the absorbant. Substances which decrease interfacial tension are called surface-active substances.

A substance can be considered surface-active if its molecules are asymmetric and contain polar hydrophilic groups and non-polar hydrophobic groups. The molecules of surface-active substances become more absorbent, the more distinctively marked the asymmetry of hydrophobic groups and the larger the differences in polarity of both phases (the absorbing substance and the absorbant) comprising the adjacent surface.

Forces aimed at decreasing free surface energy by decreasing surface tension, act on the adjacent surface. The decreasing surface energy causes the structure to loosen, enabling physico-chemically active substances to penetrate it. Due to the surface and internal stability of the structure of crystalline substances, the only means of decreasing the surface energy and saturation of forces acting the surface of such substances, is to tie extraneous molecules from the environment. The decrease in the surface energy of a solid caused by the saturation of its internal space with molecules of a polar liquid is usually much lower than the surface energy of the liquid itself (Robertson and Mills 1985).

In the case of non-polar liquids, such as benzene or paraffin, a loss of strength is not observed, since, due to their non-polarity and the diameter of their molecules (which is 2–3 times larger than that of water molecules), they are unable to effectively penetrate the porous cement structure. Smaller crude oil fractions, in which polar molecules are smaller than water molecules, lose their ability to penetrate gel pores by means of molecular sieve.

The mechanism of adhesiveness between the cement matrix and aggregate, as well as the cement matrix and reinforcements, and the coinciding operating contact zone destruction caused by crude oil products, are most likely connected with the wedging effect, which occurs on the liquid-solid interface. This phenomenon has been known for years in metal technology, and used in their processing processes. Rebinder and Lichtman obtained interesting data during their research focusing on the influence of surface active molecules contained in lubricants on metal processing procedures, especially sawing and turnery. In their works (Лихтман *et al.* 1954, 1962), they proved that noticeable softening of metal surfaces can be observed in the presence of polar molecules. In this environment, the increased softening effect has an energy-forced character and is caused by the surface energy of a solid. When a micro-crack is present on a solid's surface, polar molecules penetrate it, along the walls towards its tip, until they reach the point at which the crack's dimensions prevent further penetration (Fig. 12).

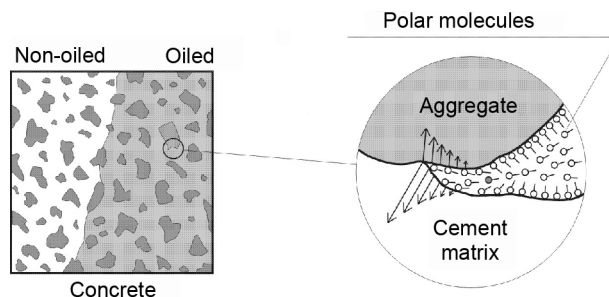

Fig. 12. Wedging effect and the influence of polar molecules (Błaszczyński 1992)

As the collision between the molecules and the surface increases, wedging pressure (marked in the figure by arrows) occurs, resulting in the weakening of bonds and widening of cracks. Due to interaction of the solid molecules and surface-active molecules, further migration of the later can lead to the slow (without internal energy loss) splitting of solid molecules. The internal splitting kinetics of a structure is determined by the penetration speed, from the surface-active substance to the deteriorated surface, of polar molecules. The dispersed molecules, moving into the newly created (as an effect of wedging) spaces of micro-cracks, prevent the cracks from closing, which accelerates the destruction process. The internal cracking progress is defined by the movement speed of molecules along newly created surfaces towards the new apex of the crack. The splitting action of solutions containing surface-active molecules is considerably stronger than that of basic substances, and has no direct connection with its viscosity.

The wedging effect has been proven by microstructural research, conducted by Onadolu (1986), on concrete samples saturated with crude oil. In Fig. 13a destruction, including progressive cracking and adhesiveness between the aggregate and cement stone, can be observed. Results of the wedging effect are also visible in Fig. 13b, which presents a piece of loose concrete from a reinforced concrete element.

Each splitting causes the surface-active molecules to deposit on the walls, becoming eliminated from the penetrating substance. At some point, a critical saturation of surface-active molecules is reached (all surface-active molecules are eliminated from the oil phase), which stops the further decrease in strength. Therefore, in the event of too few surface-active molecules water that isn't surrounded by them is able to act upon and bond to the cement stone structure. If an organic polar substance is not delivered simultaneously, water molecules begin to prevail. A similar migration process follows but, this time, with a water system which causes renovation and strengthening of the bonds, and leading to an increase in concrete strength. This phenomenon explains the various effects observed in studies regarding the influence of mineral oils.

The influence of M-40 oil, presented in Fig. 3, is caused by the small amount of surface-active molecules present in its composition, as a result of imperfections in

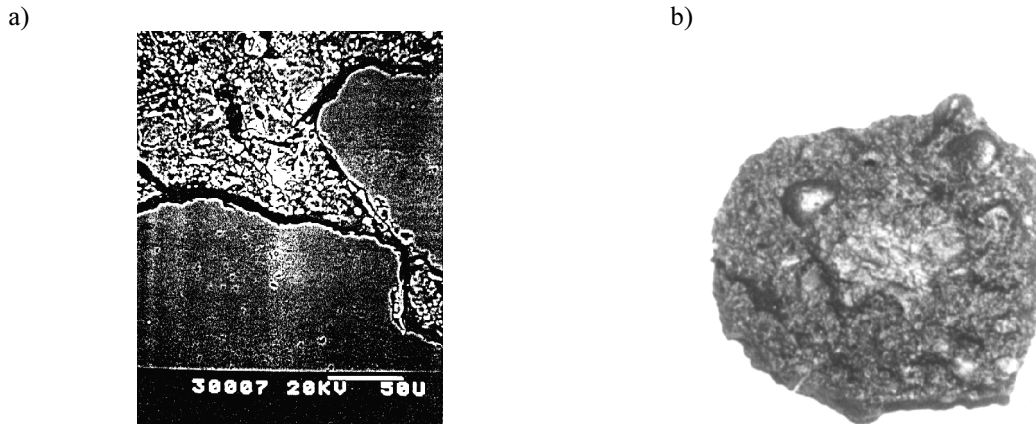

Fig. 13. Results of the wedging effect: a) contact zone photomicrography of the influence of crude oil on concrete after 365 days (Onabolu 1986); b) a loose piece of concrete from an oiled RC structure

the refining process of its oil base. Machine oils are one-fraction hydrocarbons, containing a very small amount of organic surface-active improvement additives. Results for Wrzecion 2 oil, similar to those for M-40, obtained by Grabiec (1973) and Dominas (1970), can be explained by the fact that it is the same machine oil, but with a considerably reduced viscosity (owing to its use in high-speed spindles). The effects of machine oils have been established by the latest research conducted by Runkiewicz *et al.* (2002), during which L-AN 22 machine oil was tested. The above research stands as evidence that oil viscosity does not lead to changes in the physico-mechanical features of concrete and reinforced concrete. Although the values of kinematical viscosity of the analyzed oils differed vastly at a temperature of 50 °C (Wrzecion 2–8 mm²/s, L-AN 22 – 22 mm²/s, M-40 – 40 mm²/s), their influence was comparable.

Turbine (TU-20) and hydraulic (H-70) oils are multi-fractional compositions, of varying refining rates and distinctive amounts of improvement additives. Hydraulic oils are composed of oil bases with a medium refining rate, containing a small amount of polar contaminants, while turbine oil bases are well purified.

Lux 10 oil, used by Grabiec (1973), is non-improvement oil, containing small amounts of polar contaminants. It contains polar remains – creosols and furfuryl alcohol, acquired during the production process. The transmission of Lux 10 oil through a column containing silicone gel caused the separating of these substances

along with the absorption of a portion of the aromatic hydrocarbons into the column's contents. The quantity of these substances did not exceed 0.01%, which explains such small decreases in strength which later tended to increase, observed in Grabiec's experiments.

As a whole, the phenomenon of the physico-chemical influence of organic substances depends on the competition between organic surface-active molecules contained in these substances with a liquid the polarity of which is comparable to that of water. The competition, in proportion to the positive influence of water, can be called the internal hydrophobization of concrete structures, because molecules containing long hydrocarbon-chains hydrophobize the cement stone, preventing water molecules from penetrating the created limiting layer, thus, impeding cement grain hydration. This was proven by derivatographic research conducted on concrete samples oiled with TU-20 oil (Kozarczewski 1987). In the above studies, it was stated that the presence of C-S-H phase contents in TU-20 oil is smaller than under normal maturing conditions. The comparison of derivatograms (peak height) of non-oiled and oiled samples reveals that in the case of the later ones the C-S-H phase is restricted; these findings were also confirmed by Onabolu's microstructural research (Onabolu 1986).

Fig. 14b presents the microsection of a sample which had been soaked with crude oil. The lack of certain crystalline phases is clearly visible in comparison with the microsection of a sample not treated with crude oil (Fig. 14a).

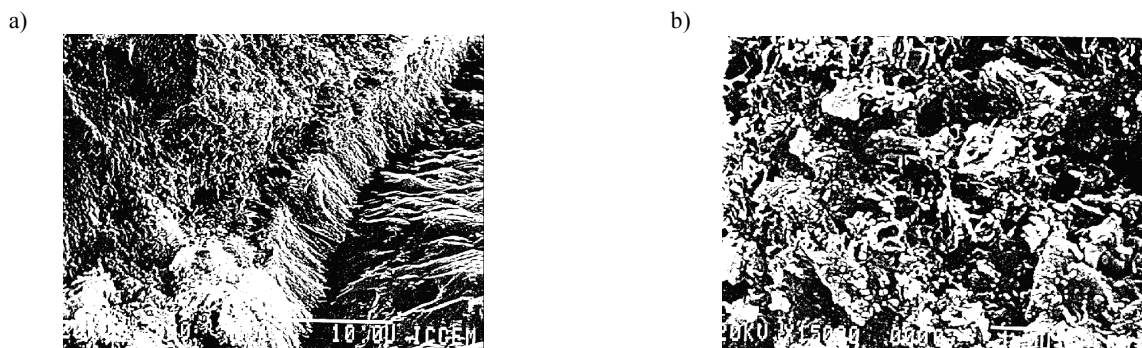

Fig. 14. Image from scanning microscopy of a concrete microstructure (Onabolu 1986): a) not subjected to the influence of crude oil; b) subjected to the influence of crude oil for 365 days

Due to the hydrophobization process, internal drying of concrete can occur, restricting the strengthening process and, thus, resulting in the occurrence of contractile micro-cracks which can be penetrated by surface-active molecules.

The comparison of the physico-chemical influence of water to that of crude oil derivatives allows one to draw conclusions regarding the harmfulness of surface-active (polar) substances containing hydrocarbon-chains. The detrimental effect of the hydrocarbon-chain occurs after it is joined to the hydrophilic polar part. This gives explanation as to why kerosene, petrol, crude oil, diesel oils and other related substances, which consist of short-chained hydrophobic parts, do have such a strong impact. In the case of fuels, water is the main polar substance, while other, also short-chained, polar molecules occur in small amounts.

In concrete, the main place of physico-chemical interference is the area of adhesiveness between the cement matrix and the aggregate and, in case of reinforced concrete, additionally the area between reinforcements and cooperating concrete. The destruction extends from the largest areas (large grain aggregate adhesive area) to the smallest ones (small grain aggregate – sand – adhesive area). Faiyadh (1980) showed that strength loss caused by the influence of crude oil on the same classes of concrete is larger for concrete containing 20 mm aggregate than of that, which contains 10 mm aggregate. Koroleva (1993) believes that, with the lack of satisfactory aggregate and cement matrix adhesiveness, the compression strength of some concretes can decrease up to 14% and, in some cases, even up to 20%. The quality of the contact zone influences not only concrete strength and deformability, but, to a great extent, its durability as well. This area increases considerably in the case of high-strength concretes. Contamination of the aggregate with various substances, such as oils, asphalts and other organic matter, significantly decreases the energy of the contact area net. A thin layer of paraffin wax, covering the surface of thick granite aggregate, reduces concrete compression strength by 30–35%, and its tensile strength by 37%. In the case of limestone aggregate, these values are twice as large Flaga (1971). The same phenomenon occurs when the aggregate is contaminated with a thin layer of clay. This significantly impacts the size of the contact area, and leads to a decrease in concrete strength, crack resistance and durability. Contamination of an aggregate's surface can reduce concrete bending strength by 10–20% while lowering its fatigue strength fourfold.

When comparing the influence of water and organic molecules over time, it can be stated that, in case of water, an initial dramatic decrease in strength is followed by its increase, which attests that the positive chemical influence of water on the cement matrix is stronger than its negative, physico-chemical effect. At the same time, the influence of surface-active molecules present in mineral oil derivatives has an adverse effect (Fig. 1), mainly due to the wedging effect, which does not occur in the case of water, but can occur in the contact zone between concrete and steel bars.

The negative influence of RC structure oiling with crude oil products, over time, applies not only to concrete structures and the contact zone, but to reinforcements as well. Fortunately, crude oil products are not harmful to reinforcements until they become biologically or chemically active. In the event of biologically or chemically active environments, the protection of reinforcing steel from corrosion, e.g. by sulfur polymer composites, becomes necessary (Hoła and Książek 2009).

Błaszczyński and Ścigałło (2006) presented a method of evaluating the limiting capacity of a reinforced concrete element exposed to the influence of mineral oils.

4. Conclusions

The influence of crude oil products can have a very negative effect on the compressive strength of concrete, as well as its bond. Comparison of the influence of oils on compressive strength shows that TU-20 and H-70 oils decrease f_b^c the most. When comparing the effects of the analyzed oils it should be noted that the final f_b^c values of concretes exposed to oils differ significantly from the control group, and range from 55% (H-70 oil) to 10% (M-40 oil). The largest decrease was observed in the case of H-70 and TU-20 oils, but M-40 oil (with medium viscosity) did not cause f_b^c to decrease below the initial value. The change in bond stress of investigated concretes to ribbed bars over time after oiling shows that the weakening of bond is gradual and becomes stabilised after 6 years, as in the case of concrete compressive strength (Fig. 4).

On the basis of comparative analysis one can, with large probability, ascertain that artificially created physico-chemical environments cause changes comparable to those induced by universally applied industrial mineral oils. The lack of essential differences in the penetration intensity of vaseline oil and vaseline oil with 10% oleinic acid, as well as only slight changes of the compression strength among the environments created from vaseline oil and vaseline oils containing 10% and 5% oleinic acid prove that in the case of industrial mineral oils, the physical mechanism of destruction does not occur.

The physico-chemical destruction process of concrete structures is complex and ambiguous. Besides areas where hydration and carbonation processes take place, there are other areas in which such processes are restricted, as well as areas in which the wedging mechanism occurs. The concrete deterioration mechanisms present model situations (in which each occurs individually). In practice, however, all presented mechanisms can occur simultaneously, in parallel time, but at different intensity, or successively, one following another. Both in parallel and in serial time, these mechanisms influence one another through interactions between their products and by chemically and physico-chemically induced changes in the concrete structure, which affect the preceding phenomena.

For the first time, all destruction mechanisms caused by crude oil products were introduced and systematised. The

physico-chemical mechanism is most common, while the biological mechanism can occur only in a water-oil environment, which exists in the case of industrial structures.

Protection to crude oil products could be done by surface coating of RC elements. Only not cracking coatings are successful in case of crude oil products influence. Interesting modeling of corrosion protection for reinforced concrete structures with surface coatings is presented in Kamaitis (2008, 2009).

References

- Biczok, J. 1972. *Concrete corrosion – Concrete protection*. 8th ed. Budapest: Akademiai Kiado. 545 p.
- Błaszczczyński, T. 1992. Influence of physico-chemical agent on the cement composite materials, *Physico-Chemical Mechanics* 20: 19–23. Bulgarian Academy of Sciences.
- Błaszczczyński, T. 1994. Durability analysis of RC structures exposed to a physico-chemical environment, in *Proc. of the 3rd Kerensky Conference*, Singapore, 67–70.
- Błaszczczyński, T. 1995. *Destrukcja betonu pod wpływem produktów ropopochodnych* [The destruction of concrete under the influence of oil products]. Poznań: Wyd. Politechniki Poznańskiej. 133 p.
- Błaszczczyński, T. 2002. Some effects of crude oil environment on RC structures, *Foundations of Civil and Environmental Engineering* 2: 7–14.
- Błaszczczyński, T.; Ściągło, J. 2006. Assessment of ultimate bearing capacity of RC sections affected by mineral oil, *Archives of Civil and Mechanical Engineering* 6(2): 41–56.
- Błaszczczyński, T.; Kozarzewski, J.; Nowakowski, B. 1985. Wpływ zaolejenia na beton fundamentów pod maszyny [Effect of oil on the concrete foundations under machinery], *Inżynieria i Budownictwo* [Engineering and Construction] 5–6: 196–199.
- Brauer, V. 1985. Öldichte Fundamente, *Schmierungsstechnik* 16(11): 347.
- Czarnecki, L.; Broniewski, T.; Henning, O. 1994. *Chemia w budownictwie* [Chemicals in construction]. Warszawa: Arkady. 334 p.
- Dahan, R. A. 1984. *Organic acid intake of crude oil in North Sea oil storage tanks as affected by aerobic bacterial activity*: MSc Dissertation, London: Imperial College, Civil Engineering Department.
- Dominas, S. 1970. Wstępne badania cech wytrzymałościowych betonu w środowisku oleju mineralnego [Preliminary investigations of the characteristics of strength of concrete in the environment of mineral oil], *Prace Naukowe Instytutu Budownictwa Politechniki Wrocławskiej* [Scientific Papers of the Institute of Civil Engineering of Wrocław University of Technology], 3. Wrocław.
- Esfahani, R.; Rangan, V. 1998. Local bond strength of reinforcing bars in normal strength and high-strength concrete, *ACI Structural Journal* 95(2): 96–106.
- Faiyadh, F. I. 1980. *Properties of oil saturated concrete*: Ph.D. Thesis, University of Sheffield.
- Flaga, K. 1971. Energetyczne podstawy wzrostu wytrzymałości betonu tężejącego w warunkach obróbki termicznej [Energetic basis for increased concrete strength under heat treatment], *Zeszyty Naukowe Politechniki Krakowskiej* [Scientific Papers of the Institute of Civil Engineering of Wrocław University of Technology] 40(3).
- Grabiec, K. 1973. Wpływ olejów mineralnych na wytrzymałość i odkształcalność betonów konstrukcyjnych [Effect of mineral oil on the strength and deformability of concrete construction], *ALL* 19(3): 567–572.
- Gruener, M. 1983. *Korozja i ochrona betonu* [Corrosion and protection of concrete]. Warszawa: Arkady. 252 p.
- Hoła, J.; Książek, M. 2009. Research on usability of sulphur polymer composite for corrosion protection of reinforcing steel in concrete, *Archives of Civil and Mechanical Engineering* 9(1): 47–59.
- Kamaitis, Z. 2008. Modelling of corrosion protection for reinforced concrete structures with surface coatings, *Journal of Civil Engineering and Management* 14(4): 241–249. doi:10.3846/1392-3730.2008.14.23
- Kamaitis, Z. 2009. Modelling of corrosion protection as standby system for coated reinforced concrete structures, *Journal of Civil Engineering and Management* 15(4): 387–394. doi:10.3846/1392-3730.2009.15.387-394
- Kawai, K.; Kohno, K.; Morinaga, T.; Tazawa, E. 1997. Effect of organic and carbonic acids on concrete deterioration caused by aerobic microorganisms, *Concrete Library International* 30: 424–437.
- Kimura, H.; Jirsa, J. 1992. Effects of bar deformation and concrete strength on bond of reinforcing steel to Concrete, in *Proc. of International Conference on Bond in Concrete*, Riga, Latvia, 117–122.
- Khoury, G. A. 1981. *Effect of hot oil on concrete*: Report No. 1. London: Imperial College.
- Khoury, G. A.; Sullivan, P. J. E.; Dahan, R. A.; Onabolu, O. A. 1985. Organic acid intake of crude oil in North Sea oil storage tanks as affected by aerobic bacterial activity, *Petroleum Review* 39(9): 42–45.
- Koroleva, G. P. 1993. Influence of the quality of contact between aggregate and cement stone on concrete strength, in *The Conference on Analytical Models and New Concepts in Mechanics of Structural Concrete*. Białystok, 299–319.
- Kozarzewski, J. 1987. *Wpływ olejów mineralnych na niektóre cechy fizyczne i mechaniczne betonów cementowych* [Effect of mineral oil on some physical and mechanical properties of cement concrete]: Ph.D. thesis, Poznań: Politechnika Poznańska.
- Manns, W.; Hartmann, E. 1977. Zum Einfluss von Mineralölen auf die Festigkeit von Beton, *Schriftenreihe des DAfStb*, Ernst, 289.
- Morgan, T. D. B.; Steele, A. D.; Gilbert, P. D. 1983. Concrete durability in acidic stagnant environment, in *Proc. of International Conference on Microbial Corrosion*, Teddington, 66–73.
- Onabolu, O. A. 1986. *Effects of hot crude oil on concrete for offshore storage applications*: Ph.D. Thesis, London: Imperial College of Science and Technology.
- Onabolu, O. A.; Khoury, G. A.; Sullivan, P. J. E. 1985. Inorganic acid content of NS oil: effect of anaerobic bacterial activity in tanks, *Petroleum Review* 39: 42–45.
- Pędziwiatr, J. 2008. Influence of internal cracks on bond in cracked concrete structures, *Archives of Civil and Mechanical Engineering* 8(3): 91–105.
- Piasta, J.; Piasta, W. G. 1994. *Beton zwykły* [Plain Concrete]. Warszawa: Arkady. 200 p.
- Pluta, J.; Ciał, A.; Skorupski, W. 1980. Korozja olejowa betonu konstrukcji stropów w magazynach produktów naftowych [Oil caused corrosion of concrete structures' ceiling in storage of petroleum products], in *Proc. of XXVII konferencja KILiW PAN i KN PZITB*, Krynica, 197–203. PN-85/C-04066. *Przetwory naftowe. Oznaczanie liczby kwasowej i zasadowej oraz kwasowości metodą miareczkowania*

- wobec wskaźników [Petroleum products. Determination of the acid or alkaline and acidity by titration against indicators]. Poland. 1985.
- Postgate, J. R. 1979. *The sulphate reducing bacteria*. Cambridge: Cambridge University Press. 151 p.
- RILEM/CEB/FIP. 1983. *Recommendations on reinforcement steel for reinforced concrete*, Revised edition of RC6 Bond test for reinforcement steel: (2). Pull-out test, CEB News, May, 73.
- Robertson, B.; Mills, R. H. 1985. Influence of sorbed fluids on compressive strength of cement paste, *Cement and Concrete Research* 15(2): 225–232.
doi:10.1016/0008-8846(85)90033-X
- Romben, L. 1978. *Aspects on testing methods for acid attack on concrete*. Swedish Cement and Research Institute, Research 1:78, Stockholm.
- Runkiewicz, L.; Konieczny, K.; Brzek, R. 2002. Zmiany wytrzymałości i odkształcalności betonu zaolejonego w konstrukcji [Changes in the strength and deformability of concrete oiled in construction], *Przegląd Budowlany [Construction Overview]* 2: 26–29.
- Ścisławski, Z. 1999. *Ochrona konstrukcji żelbetowych* [Protection of reinforced concrete structures]. Warszawa: Arkady. 196 p.
- Soretz, S.; Hölzenbein, H. 1979. Influence of Rib Dimension of Reinforcing Bars on Bond and Bendability, *ACI Journal* 76(1): 111–125.
- Steinbach, W. 1967. Über die Einwirkung von Mineralölen auf die Festigkeit von Zementmörtel, *Betonsteinzeitung* 33(10): 462–469.
- Tscherner, J. 1986. Schutz von Beton vor Mineralölprodukten, *Schmierungstechnik* 17(7): 217–222.
- Vorläufiges Merkblatt über das Verhalten von Beton gegenüber Mineral- und Teerölen. 1966. Herg. Vom Arbeitskreis
- „Öleinwirkungen“ des VDZ, *Beton Herstellung Verwendung* 16(11): 461–463.
- Wilkinson, T. G. 1983. Offshore monitoring, in *Proc. of International Conference on Microbial Corrosion*, Teddington, 117–122.
- Weiss, G. 1961. Erfahrungen bei einer Betonschädigung durch Ölkorrosion, *Zentralblatt der ungarischen Technik* 13(3): 107.
- Васильев, Н. М. 1981. Влияние нефтепродуктов на прочность бетона [Vasiliev, N. M. Effect of oil on the strength of concrete], *Бетон и железобетон [Concrete and Reinforced Concrete]* 3: 36–37.
- Лихтман, В. И.; Ребиндер, Р. А.; Карпенко, Г. В. 1954. Влияние поверхностно-активной среды на процессы деформации металлов [Lichtman, V. I.; Rebinder, R. A.; Karpenko, G. V. Influence of surface-active environment on the deformation processes of metals]. Москва: АН СССР. 348 с.
- Лихтман, В. И.; Щукин, Е. Д.; Ребиндер, Р. А. 1962. *Физическая механика металлов* [Lichtman, V. I.; Chukin, E. D.; Rebinder, R. A. Physical mechanics of metals]. Москва: АН СССР. 348 с.
- Миловидов, И. В.; Алексеева, Г. В. 1970. Снижение прочности бетона от воздействия масел [Milovidov, I. V.; Alekseeva, G. V. Reduction of concrete strength by the effects of oils], *Промышленное строительство [Industrial construction]* 1: 42–43.
- Ребиндер, Р. А. 1966. Поверхностно-активные вещества и их применение. Поверхностные и объемные свойства растворов поверхностно-активных веществ [Rebinder, R. A. Surface-active substances and their application. Surface and bulk properties of surfactant-active fluid of substances], *Химическая наука и промышленность [Chemical Science and Industry]* 9(4): 5–10.

NEAPDIRBTOS NAFTOS PRODUKTŲ ĮTAKA GELŽBETONIO STRUKTŪROS SUARDYMI

T. Z. Błaszczyński

Santrauka

Yra žinoma, kad gelžbetoninės pramoninės konstrukcijos yra jautrios neapdirbtos naftos produktams, o tai gali turėti neigiamą įtaką jų eksploatacijai ir saugumui. Šiame tyrime analizuojama neapdirbtos naftos produktų įtaka brandaus betono fiziniams ir mechaniniams savybėms, aptariamai galimi poveikiai, skatinantys progresyvų gelžbetonio irimą. Buvo nustatyta, kad neapdirbtos naftos produktai, turintys labai žemą neutralizavimo laipsnį, yra fiziniai ir cheminiai reagentai, veikiantys betoną. Straipsnyje aptariamas eksperimentas, kuris buvo atliktas siekiant įvertinti betono stiprį gniuždant ir jo sukibtį su armatūra. Buvo atlikti ilgai trunkantys bandymai, siekiant nustatyti neapdirbtos naftos produktų grupės – mineralinių naftos produktų – poveikį betono savybėms ir armatūros bandiniams. Šiame straipsnyje pateikiami išsamūs tyrimų rezultatai. Skirtingų mineralinių naftos produktų poveikio betono stipriui palyginimas leidžia daryti išvadą, kad poveikiai gali būti labai skirtingi. Straipsnyje stengiamasi atsakyti į klausimą – kaip keičiasi gelžbetonio sukibtis laikui bėgant, jo neapsaugojus nuo mineralinių naftos produktų poveikio. Natūralios drėgmės sąlygomis organinių reagentų įtaka betonui ir jo sukibčiai daugiausia priklauso nuo jo struktūros. Veikiant naftos produktams galimi keturi pagrindiniai poveikiai – biologinis, cheminis, fizinis, fizinis ir cheminis, kurie veikia betoną, jo sukibimą ir kartais armatūrą. Kiekvienas šių poveikių yra aptariamas straipsnyje. Siekiant įrodyti teiginį, kad aktyvios paviršiaus polinės molekulės, esančios aktyviuose reagentuose, yra priežastis, dėl kurios betoną veikiama neapdirbtos naftos produktų, buvo atlikti būtini laboratoriniai bandymai. Atlikti eksperimentai parodė, kad dirbtinės aplinkos poveikiai (betonui), sumodeliuoti autoriaus, yra tokie patys kaip ir tie, kurie atsiranda dėl plačiai naudojamų pramoninių naftos produktų.

Reikšminiai žodžiai: gelžbetoninės konstrukcijos, neapdirbtos naftos produktų įtaka, betoną ardantys poveikiai, stipris gniuždant, armatūros įtempiai, aktyvios polinės paviršiaus molekulės.

Tomasz Z. BŁASZCZYŃSKI. Dr Habil. Eur. Ing., Dept of Building and Environmental Engineering, Poznan University of Technology, Poland. Member of IABSE since 1997, of Institution of Structural Engineering since 1990. Also member of CTBUH, IAEE, IASS. Author and co-author of more than 90 publications, including 3 books and more than 250 expert reports. Research interests: special structures and tall buildings, structural analysis, construction materials, durability, monitoring and refurbishment.